

INDUSTRIAL SOLENOIDS

ON/OFF DC D12 - NG04 | PRODUCT DETAIL

Specification	Value
Voltages	12-24 VDC
Power Consumption	20 Watt, 26 Watt
Duty Cycle	S1 100% E.D.
Ambient Temperature	-50°C to +50°C
Winding Insulation	Class H
Electrical Connections	ISO4400, DEUTSCH
Pressure Rating	210 Bar NFPA T2.6.I R2-2000
Vibration Resistance	24 Hrs, @ 20g @ 50-600Hz
Surge Suppression Options	Uni-Diode, Bi-Diode
Mechanical Stroke	Various Working, >5.4mm Total
Ingress Protection	Up to IP67, IP69K (Limited by Connector)
Corrosion Protection	FeZnNi8, 480Hrs ASTM B117 (Plated Surfaces)

Other Features/Options

Voltages	On Request
Power	On Request
Pressure Rating	Up to 350 Bar
Override Function	With/Without
Seal Materials	NBR, FKM, HNBR
Corrosion Protection	FeZn, E-Coat Loose
Push Rod	Fixed
Other Connectors	On Request

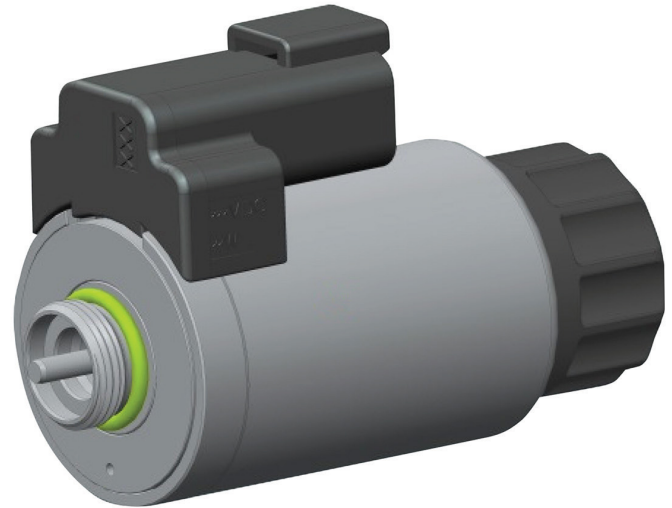

ISO 4400 / DIN 43650

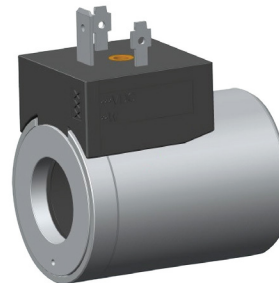

DEUTSCH DT04

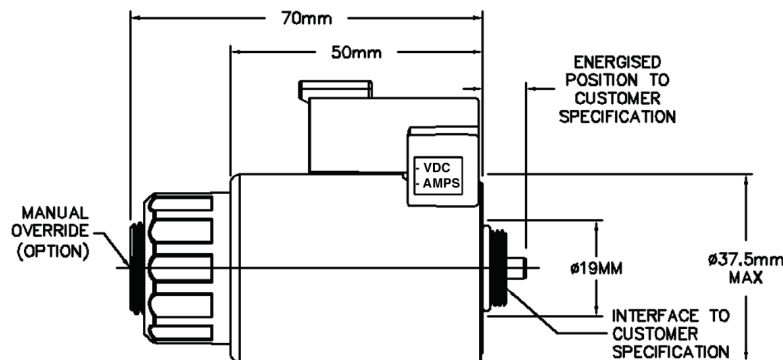
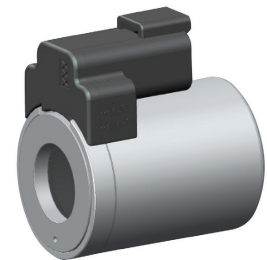

On/Off DC Industrial Solenoid D12 - NG04 DC

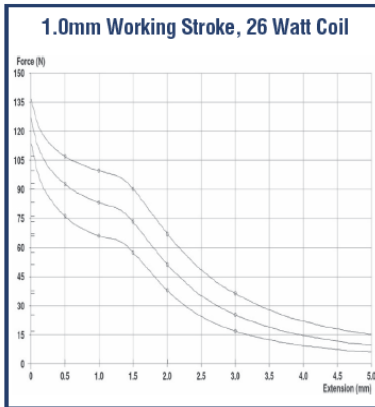
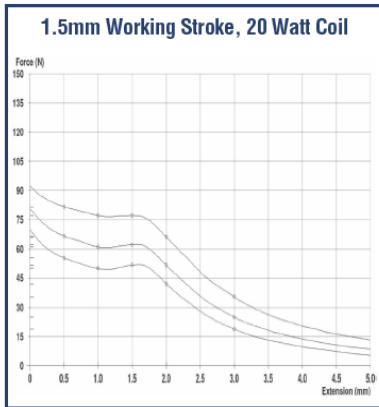
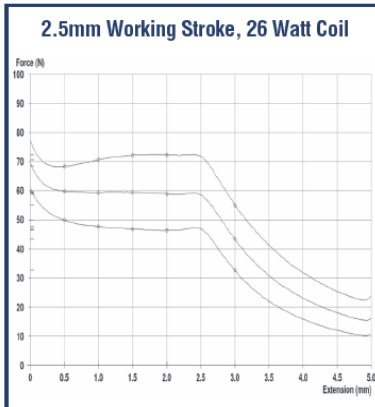
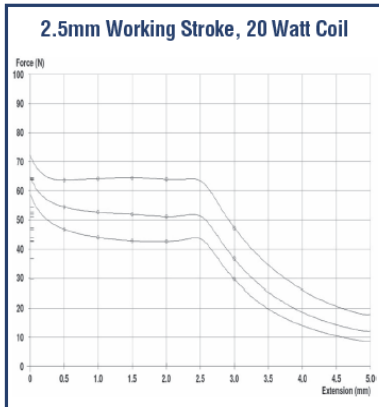

Standard Solenoid Specification

Performance Curves:

- 25°C, 100%VDC
- 50°C, 90%VDC
- Hot 90%VDC (In 25°C Ambient)



ABOUT US

We are a global leader in the design and manufacture of engineered solutions including solenoids, solenoid valves, linear and rotary position sensors, motors, electric actuators and flame arrestors. We serve hundreds of customers in diverse markets throughout the world with market-leading solutions enabled by our extensive design, test and manufacturing capabilities.

